

水槽 Milanello Workstation



水槽

代码: 1034 856



细节

材料 AISI 304 不锈钢

染色 Gun Metal

表面处理 PVD

质地 磨砂

边型和安装方式 台下

底座 90 cm

尺寸 790x466 mm

标准配件 固定钩, 垫圈, 下水器, 溢水口和虹吸管, 纸板盒包装

龙头孔 无定位孔

安装孔 [View technical data sheet](#)

下水器 否

宽 79 cm

盆内尺寸 750 x 374 mm

单槽/双槽 单槽

下水组件

特点

枪黑色 Gun
Metal表面处理是通过采用称为PVD（物理气相沉积）的物理工艺处理钢而获得的，该工艺将贵金属颗粒沉积在表面上，从而具有独特着色，并改善了钢的机械性能，从而更耐冲击和耐刮擦。

3.5" 下水器提篮 Foster®水槽均配备了3.5"下水器，有可防止固体颗粒流入下水器的实用篮式塞。3.5"下水器允许使用Foster®碎渣机，可与所有型号兼容。

三重滑轨 Foster
Milano水槽使用巧妙的设计可以同时使用多个不同的附件。最上面一层，可以放置可滑动的创新的黑搁架，可以创造一个大的工作平面来冲洗食物和餐具。第二层用来放置和滑动通用配件，可以完成洗、冲、切、剥等多种功能。第三层靠近水槽底部，你可以放置冲洗过的食物餐具而不接触槽底，既可以沥水又不怕被槽底弄脏。

溢水口 溢水口是Foster水槽上的一项安全措施，可以防止疏忽时水的溢出。方形溢水解决方案，具有简约的方形，更加美观大方。

节省空间系统 下水器和虹吸管的设计目的是在水槽下方留出尽可能多的空间，如今对于这些单独的废物收集系统越来越有用。

钻石型底部

排水是水槽的一项重要功能，在Foster产品中始终要小心处理。
在具有平底弯曲焊接水槽中，优雅的斜角确保适当的排水，有助于水流。

高厚度

1mm厚的钢。相当大的厚度，保证了最大的坚固性和耐用性。

装备

2 x 黑格架Milanello 8100 602

技术图纸

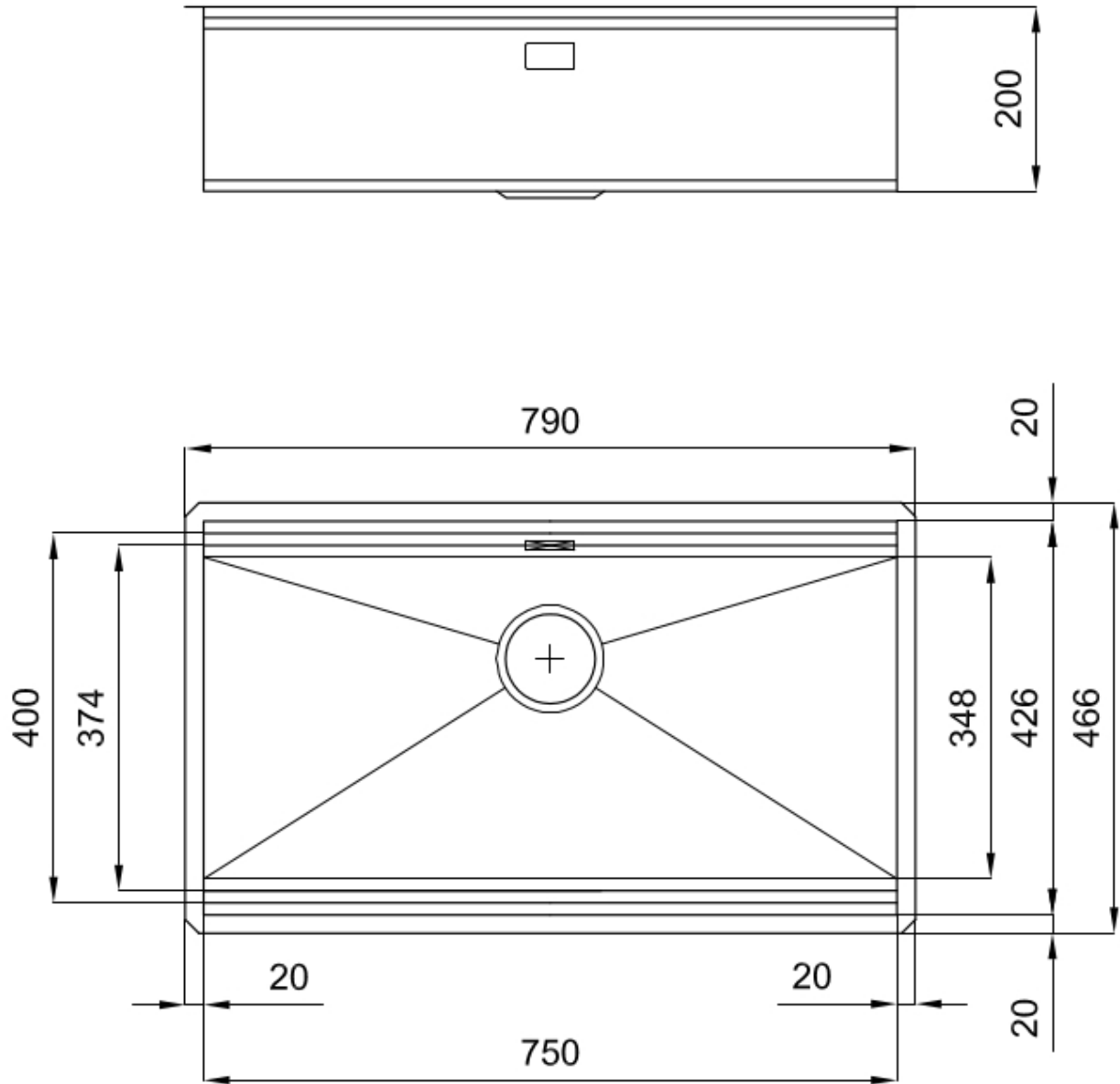

Milanello Optional accessories / Accessori opzionali

The "rails" system makes it possible to use a combination of numerous accessories. Grids, chopping boards, utensils' ranging system, bowls and containers of different dimensions can be alternated in the workspace with a simple gesture, and can easily be stacked, in order to be on hand at all times.

Il sistema di "corsie" rende possibile l'utilizzo combinato di innumerevoli accessori. Griglie, taglieri, portautensili, vaschette e contenitori di varie dimensioni si alternano nella zona di lavoro con un semplice gesto e possono essere impilati, sempre a portata di mano.

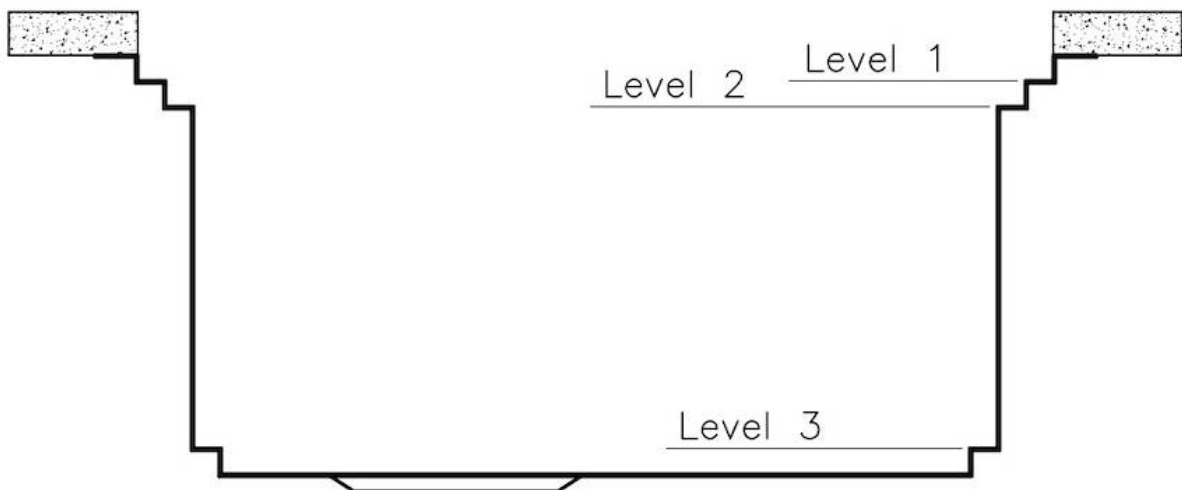

Milanello Level 1

Compatible accessories/Accessori compatibili:

8100 602
8631 300
8642 003
8644 004
8644 101
8657 001



Milanello Level 2

Compatible accessories/Accessori compatibili:

8100 306
8156 000



Milanello Level 3

Compatible accessories/Accessori compatibili:

8100 602

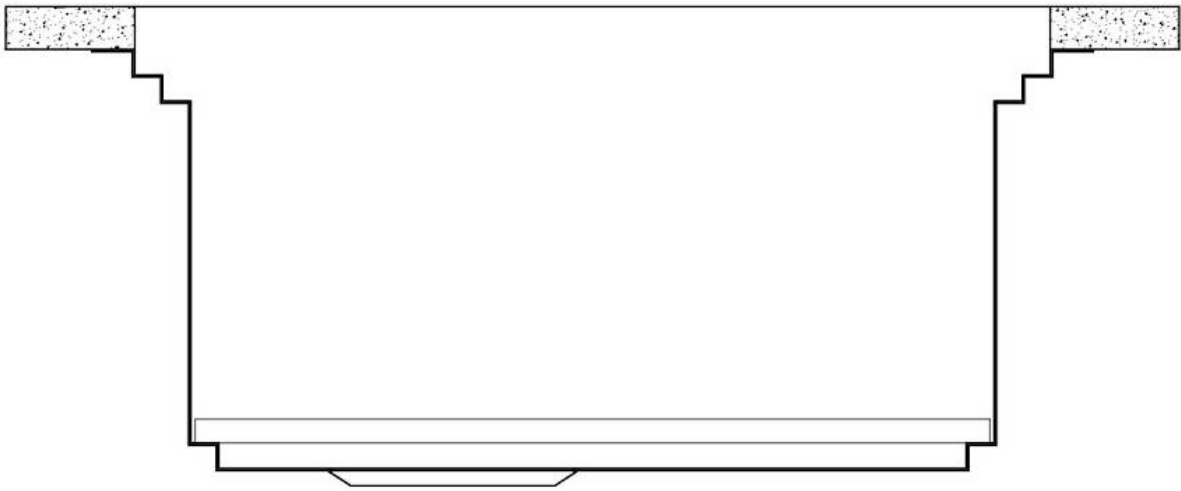

750

426

Cut out size - Dimensioni per foratura top

画廊

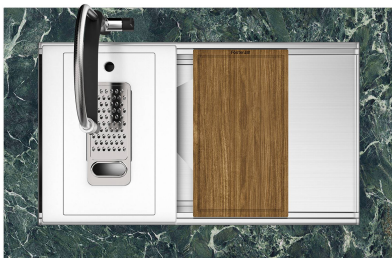
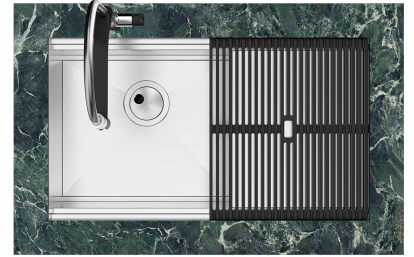
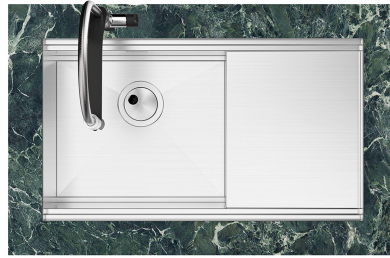

EQUIPMENT



黑格架 **Milanello**

8100 602

OPTIONAL ACCESSORIES



HDPE 砧板
8657 001



HDPE Twin 砧板
8644 101



不锈钢穿孔托盘
8156 000

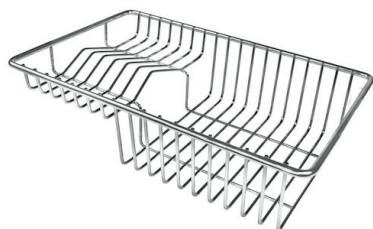

不锈钢背板
8100 303
* 仅与附件结合使用 8644 101



带不锈钢沥水篮的伊罗科木砧板
8644 044



木砧板
8642 004



玻璃砧板
8631 300

RECOMMENDED PAIRINGS

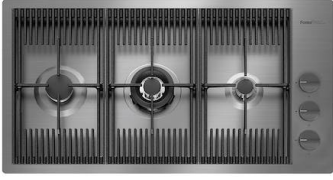

Milanello Gun Metal 燃气灶
7680 006



龙头 Milanello
8425 100



龙头 Skin Gun Metal
8424 856