

功能列表

KS 60 MF 5

型号 7122 054



Foster 

炉子的描述

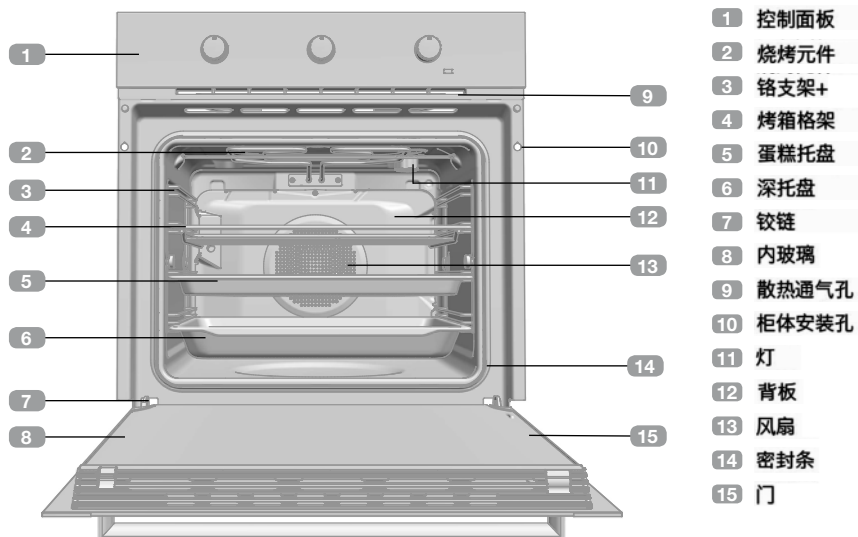

控制面板

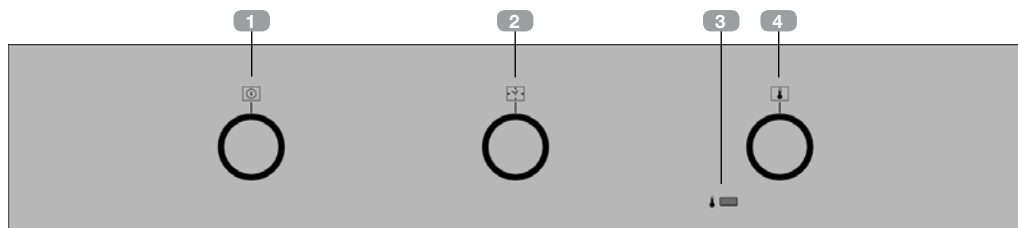

- 1 功能选择
- 2 分钟计时器开关
- 3 加热指示灯。加热食物时亮起，到后熄灭。
- 4 温度选择

功能选择器图标及功能说明



型号 KS 60 MF5



ECO



烤箱功能



信息

关于使用各功能的描述，请参考随机附带的烘焙指导表。

 下加热元件

 开风扇的传统烤炙

ECO 生态节能烤

 解冻

 快速预热



 关机

 烧烤和下加热元件

 烧烤

使用烤箱

烤箱使用手册

- 1 将分钟计时器开关向左转到位置 。
- 2 选择功能和温度
- 3 将开关旋转到位置  来关机

使用计时器开关

可以在预设的时间内烹饪食物。如下操作：

- 1 选择功能和烹饪温度
- 2 顺时针旋转计时器开关到120分钟位置，然后反向旋转到所需的烹饪时间

3 时间倒计时完成后，会有蜂鸣声。烤箱停止加热。

4 将开关旋转到  位置关机

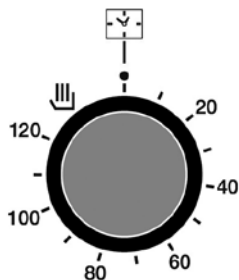



制造商	FOSTER
型号	KS 60 MF 5
能效等级, 从 A+++ (能效最佳) 到 D (能效最差)	A
加热功能	
传统加热	←
强制对流加热	
耗电量 传统加热	0.72 千瓦时
强制对流加热	0.69 千瓦时
类型:	
小	
中等	←
大	
噪音 (分贝)	---





ENERG Y IJA
енергия · ενεργεια

IE IA

Foster  **KS 60 MF 5**







70 L



0.72 kWh/cycle*



0.69 kWh/cycle*

* цикъл · cyclus · portion · zyklus · πρόγραμμα · ciclo · tsükkel · ohjelma · ciklus · ciklas · cikls · ciklu · cyclus · cykl · ciclu · program · cykel

65/2014

EEl _{cav} *	82,1
N° cav *	1
M	28kg

* затв.отдел · ovnrum · θαλάμου · prostor za rešenje · kavità · ovenruimte · incintă · prostor za peko · kavitet

